



PLA.NET®



outdoor cooking
CUCINARE ALL'APERTO

OASI

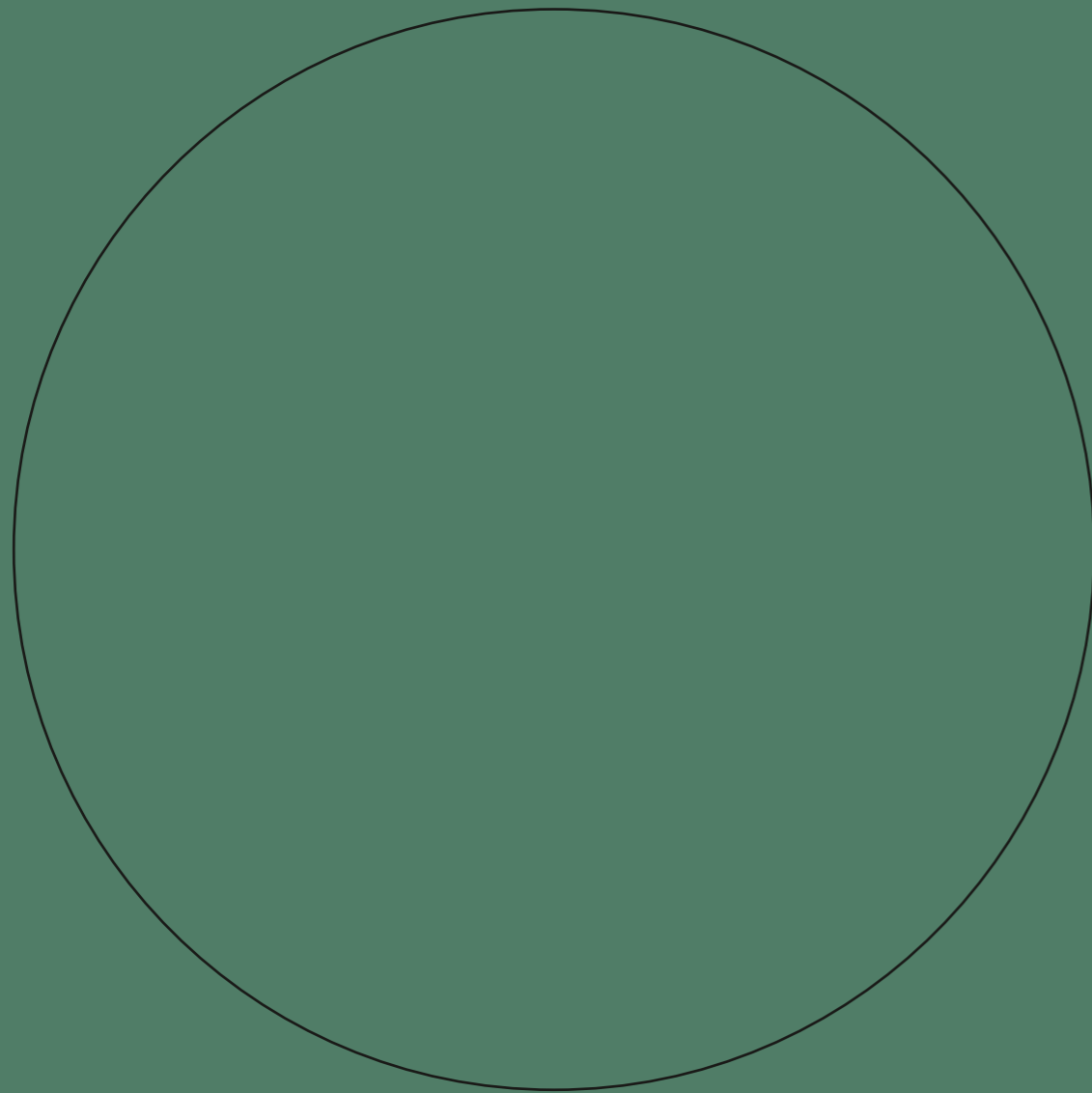

in | **out**

Il confort di una cucina

*The comfort of a kitchen
Der komfort einer außerküche
Le confort d'une cuisine*

Il piacere di stare fuori

*The pleasure of being outdoor
Das vergnügen im freien zu sein
Le plaisir du plein air*

Kitchen World

/ Cooking Solutions

FRY TOP. Identifica un piano cottura in acciaio, usato nella ristorazione professionale (ristoranti, catering, mense) o street food (furgoni attrezzati, chioschi), in tutto il mondo. Garantisce cottura rapida e igienica di pesce, molluschi, carne, verdure, prodotti vegani, ma anche hot dog, panini, eggs and bacon, crêpe. / A steel hob used in professional kitchens (restaurants, catering services, canteens) or street food (equipped vans, kiosks), all over the world. It guarantees quick and hygienic cooking of fish, shellfish, meat, vegetables, vegan products, but also hot dogs, sandwiches, eggs and bacon, crêpe.



PLANCHA. Termine spagnolo, usato anche in Francia, che significa piastra. Realizzata in vari materiali, riscaldata col fuoco, viene utilizzata per cotture all'esterno. Proposta anche dai produttori di cucine per la casa, per usarla come piano cottura sopra i fornelli, sfruttando questa fonte di calore, per cucinare "alla piastra". / Spanish term, also used in France, which means hot plate. Made of various materials, heated by fire, it is used for outdoor cooking. Also offered by home kitchen manufacturers to use as a hob above the stove, taking advantage of the heat source to cook as a "hot plate".



TEPPANYAKI. Sistema cottura di origine giapponese (teppan= piastra e yaki= grigliare). Diffusa nel mondo (a New York dal 1964), teppanyaki è anche diventato sinonimo di prodotto, piccola piastra elettrica inserita in cucina, affiancata ai fornelli. / A cooking system of Japanese origin (teppan= hot plate and yaki= to grill). Widespread throughout the world (in New York since 1964), teppanyaki has also become synonymous of a product, small electric plate placed in the kitchen along with the stove.

Outdoor Cooking

/ Solutions by PLA.NET

Puoi cucinare all'aria aperta comodo come fossi dentro casa e in sicurezza. / You can cook at open air comfortably as if you were inside your home and in complete safety.

Un piano cottura come un FRY TOP: materiale per alimenti, igienico e pulibile, con tempi di cottura anche brevissimi. / A hob like a fry top: food material, hygienic and cleanable, with very short cooking times.

Puoi cucinare di tutto: pesce e molluschi, carne, verdure, vegano e fare colazione, pranzo, cena, per 365 giorni l'anno. / You can cook anything: fish and shellfish, meat, vegetables, vegan products and prepare breakfast, lunch or dinner, 365 days a year.

Puoi trovare soluzioni e misure giuste per le tue esigenze domestiche, pratico come una PLANCHA. / You can find the right solutions and measures for your domestic needs, practical like a plancha.

Un prodotto semplice, facile da usare come cucinare su una PADELLA. / A simple product, easy to use as if cooking with a pan.

Puoi stare in compagnia mentre cucini, come nel TEPPANYAKI. / You can relax or entertain company while you cook, functional like a teppanyaki.



PADELLA. Usata ovunque in cucina, domestica o ristorante, spesso rivestita con teflon, non è altro che un piano, con bordi rialzati, che una volta riscaldata dal fuoco sottostante, consente la cottura di svariati tipi di cibo. / Used practically everywhere in the kitchen, whether domestic or restaurant, often covered with Teflon; it is nothing more than a countertop, with raised edges, which once heated, allows you to cook various types of food.

A new cooking experience (teppanyaki)



Una cucina completa di piani
cottura, fornelli, lavello,
frigo, nelle dimensioni più
adatte alle scelte di ognuno.

*A kitchen with the most
suitable dimensions for
everyone's choice, complete
with cooking plate, cooker,
fridge and sink.*

outdoor
KITCHEN

pag. 6

outdoor
STATION

pag. 14

outdoor
BUILT-IN

pag. 22



outdoor
KITCHEN

C5

**è una Cucina pronta all'uso.
Diverse combinazioni di piani
cucina, per un uso sia all'interno
che all'esterno della casa.**

*EN_C5 is a ready-to-use Kitchen. Several
kitchen tops combinations, for the use inside and
outside the house.*

*DE_C5 ist eine sofort einsatzbereite
Arbeitsstation. Es gibt zahlreiche Kombinationen
von Küchenplatten für den Gebrauch innerhalb
und außerhalb des Hauses.*

*FR_C5 est une table de cuisson plancha prête
à l'emploi. Plusieurs combinaisons de plans de
cuisine, pour une utilisation à l'intérieur et à
l'extérieur de la maison.*

designer: Marco De Luca - Francesco Massimo

OASI C5



Inox /
Stainless steel

Legno / Wood

WX



8

Vernicatura a polveri /
Powder coated

P

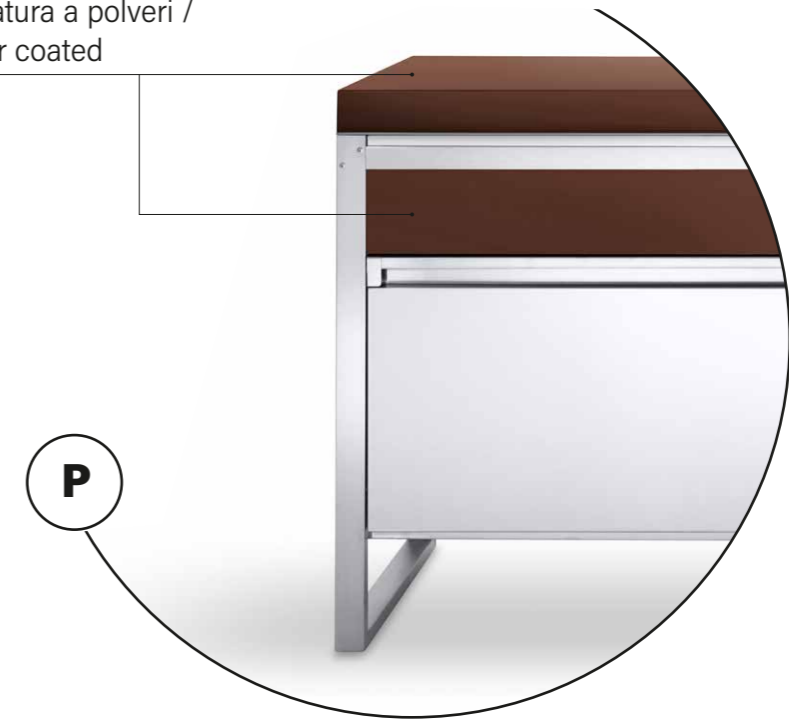

9

FLAP
Accessorio / accessory

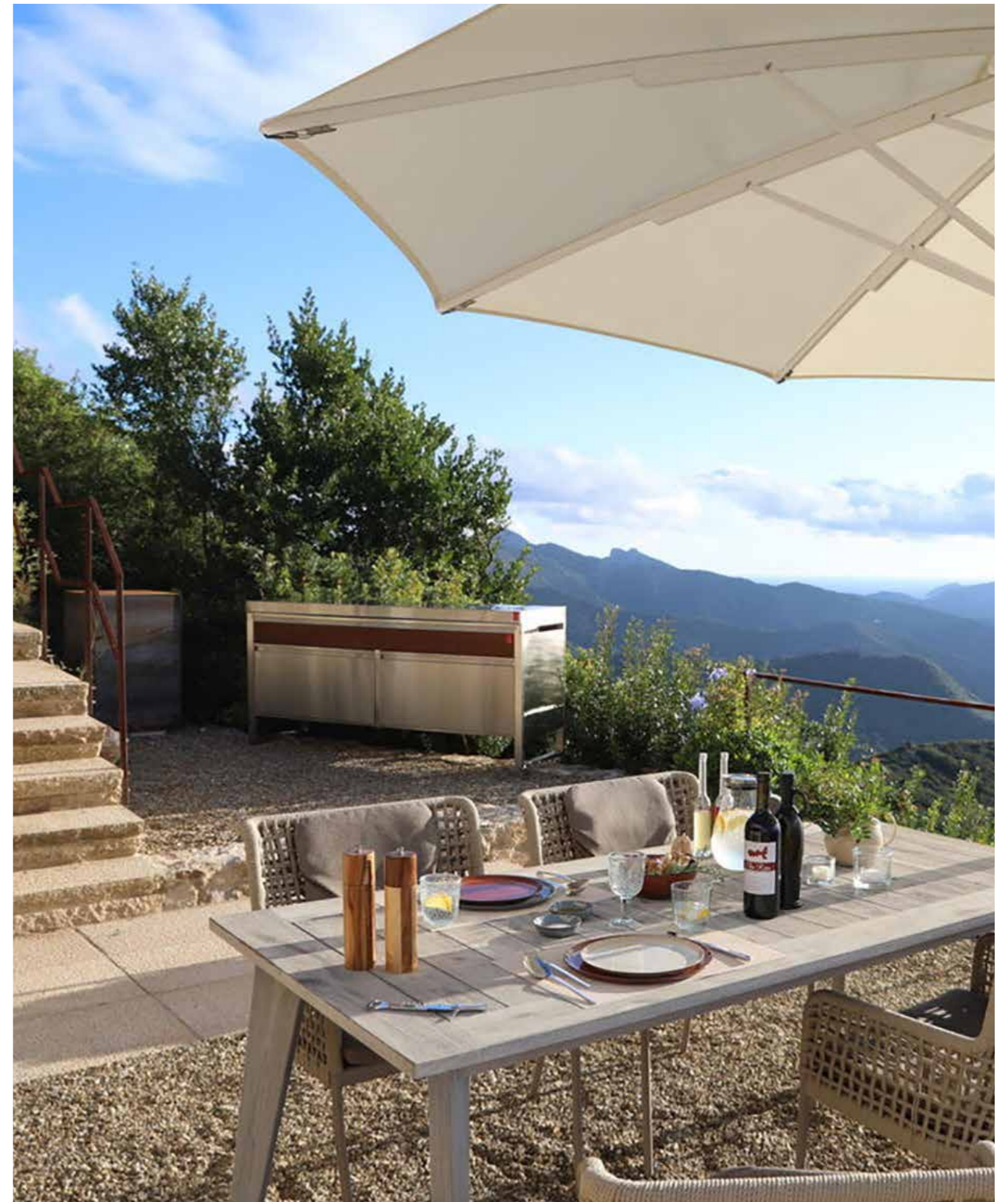
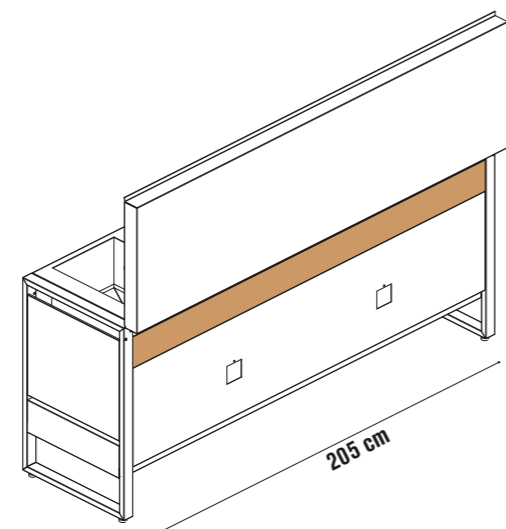
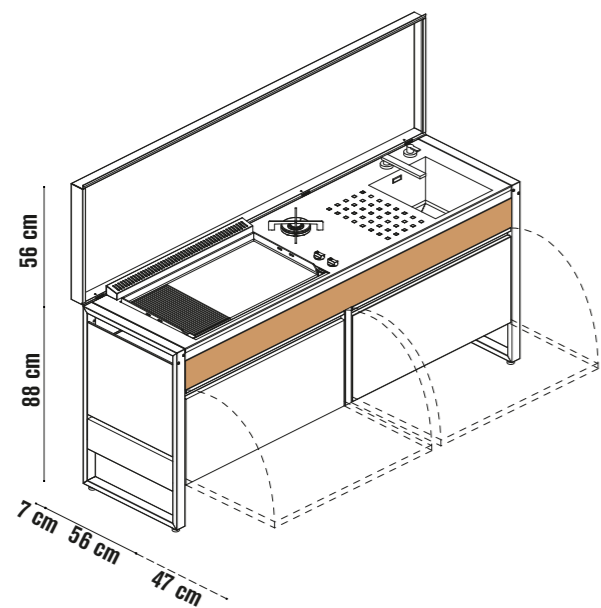
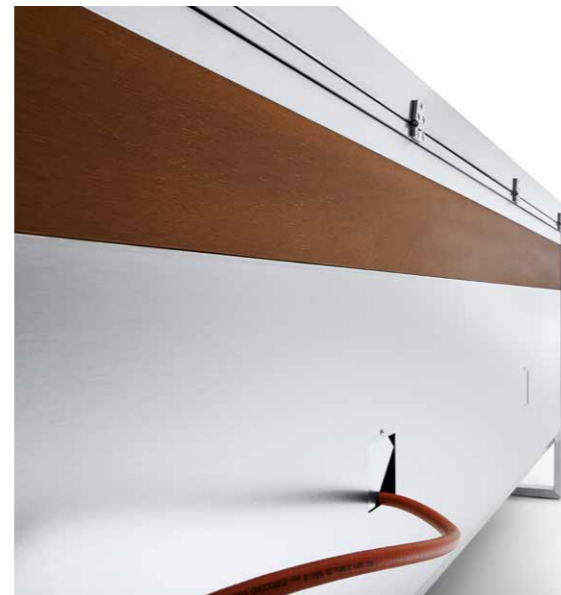

15 *Unique top
to choose*
combinazioni top unico



⚡ Electric collection

C5. T7

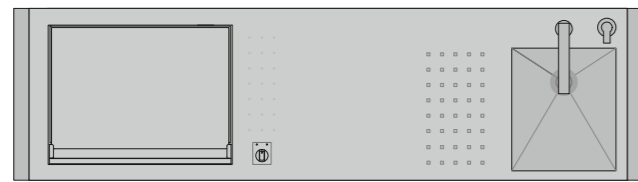

C5. T8

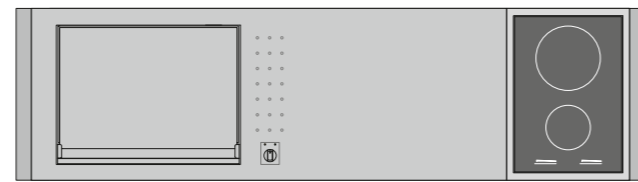

C5. T9

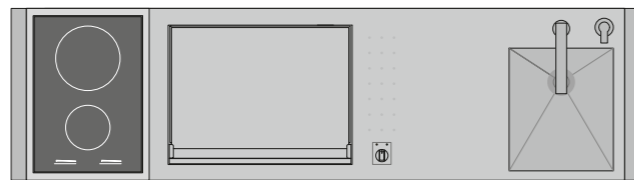

🔥 Gas collection

C5. T1

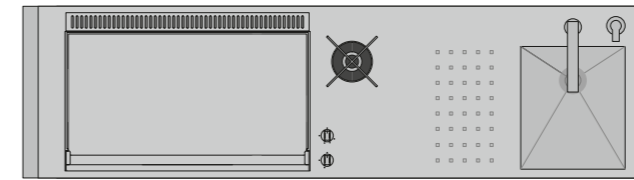

C5. T2

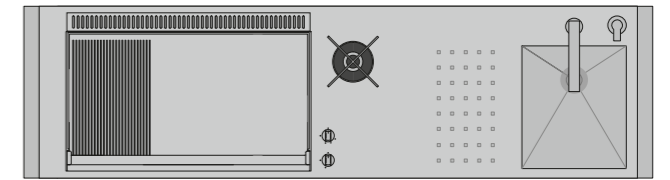

C5. T3

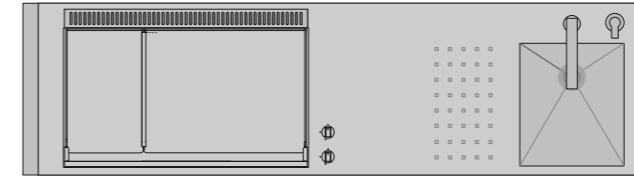

C5. T4

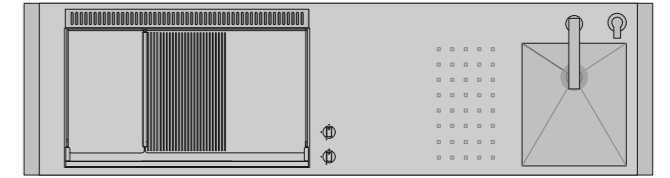

C5. T10

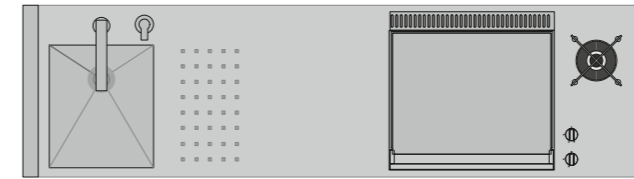

C5. T11

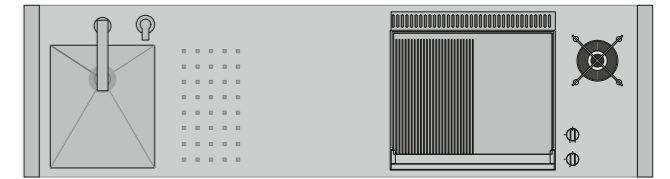

C5. T20

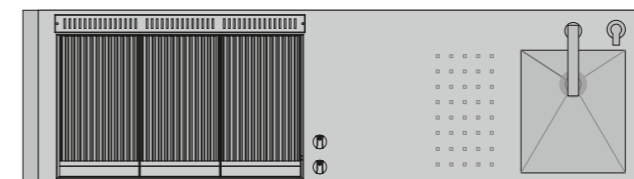

C5. T21

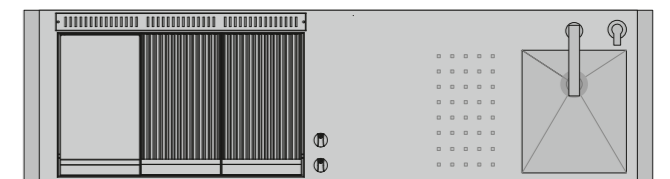

C5. T22

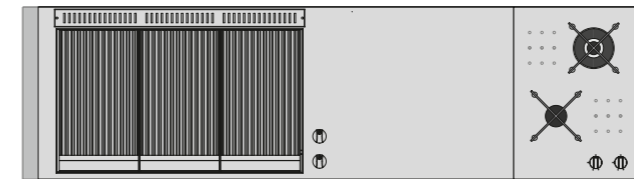

C5. T23

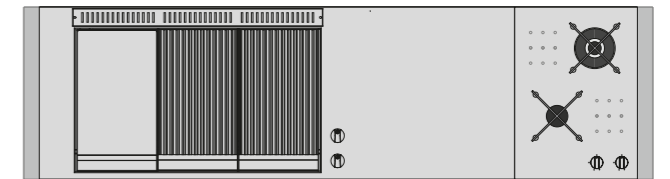

C5. T24

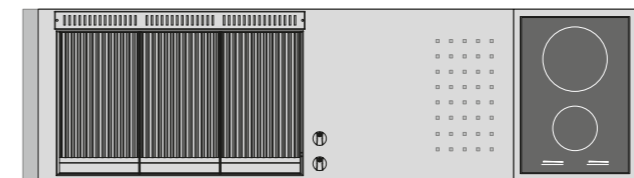

C5. T25

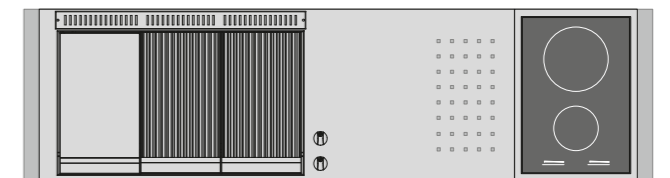



outdoor
STATION

OASI è una Work Station pronta all'uso, 4 misure disponibili e svariate combinazioni di piani cucina, per un uso sia all'interno che all'esterno della casa.

EN *OASI is a ready-to-use Workstation. Four dimensions available and several kitchen tops combinations, for the use inside and outside the house.*

DE *OASI ist eine sofort einsatzbereite Arbeitsstation. Es sind vier Dimensionen verfügbar und es gibt zahlreiche Kombinationen von Küchenplatten für den Gebrauch innerhalb und außerhalb des Hauses.*

FR *OASI est une table de cuisson plancha prête à l'emploi. Quatre dimensions disponibles et plusieurs combinaisons de plans de cuisine, pour une utilisation à l'intérieur et à l'extérieur de la maison.*

designer: Marco De Luca - Francesco Massimo

OASI 97 97.C



L.97 x P.56 H.88 cm

OASI 142.CC



L.142 x P.56 H.88 cm

Soluzioni piano standard

Standard solution



1 OASI 97 + B.IN55 COMBI.LR + IN.FLAP (x 2) + PBX (97.C CW)

Soluzioni piano standard

Standard solution

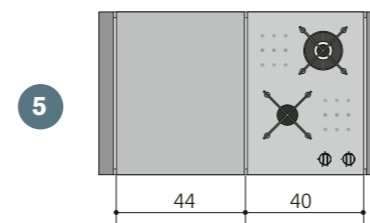
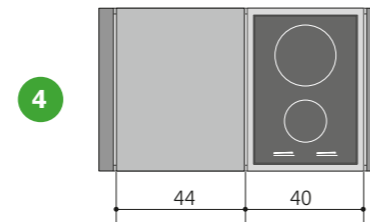
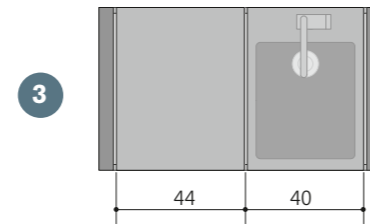

Soluzioni piano fuori standard

No standard solution

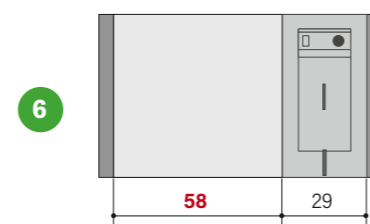

Soluzioni piano standard

Standard solution



1 OASI 142.CC WX + B.IN55 COMBI.LR



2 OASI 142.CC WX + B.IN EL60.L

Soluzioni piano fuori standard

No standard solution

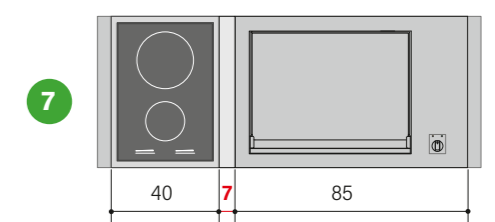
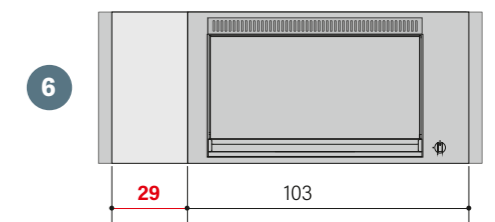
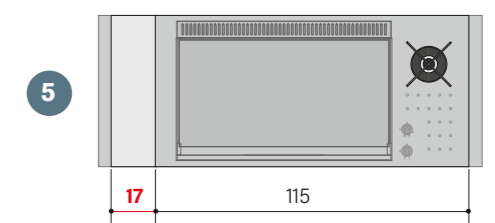
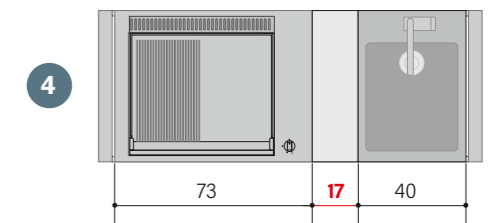
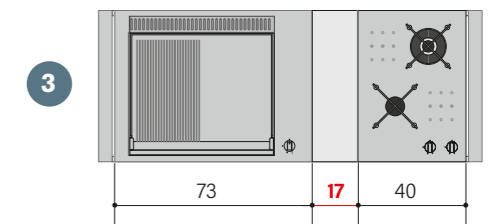

OASI 183.CC

Gas
Electric



L.183 x P.56 H.88 cm

Soluzioni piano standard Standard solution



1 OASI 183.CC WX + B.INLAV 4056 + SOTTO + B.IN 55COMBI.LR

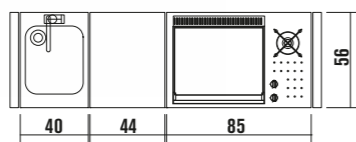

2 OASI 183.CC WX + B.IN INDU + B.IN EL60.L

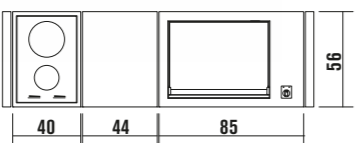

OASI 205.CC

Gas
Electric



L.205 x P.56 H.88 cm

Soluzioni piano fuori standard No standard solution

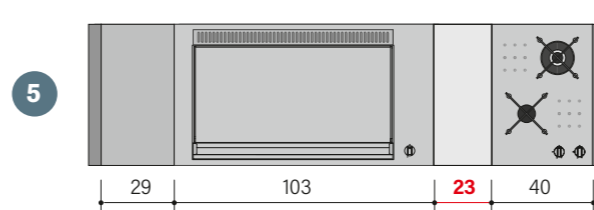
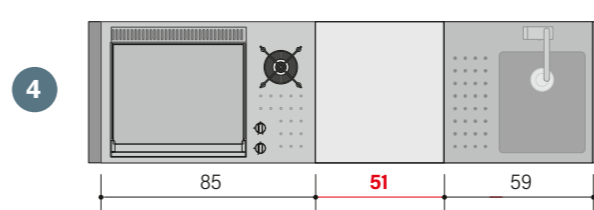
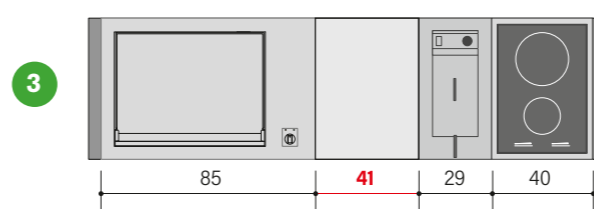
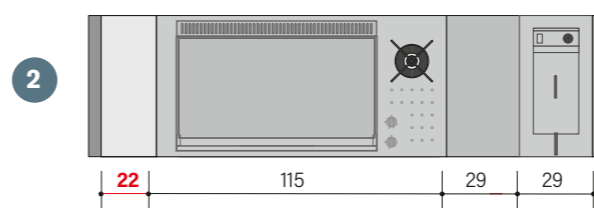
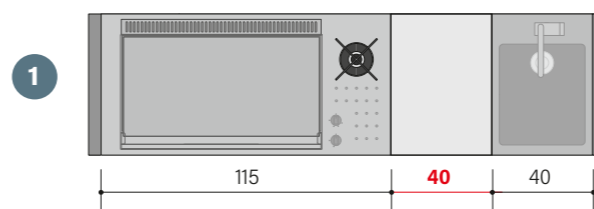

Soluzioni piano standard Standard solution

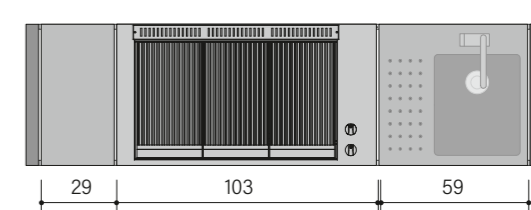
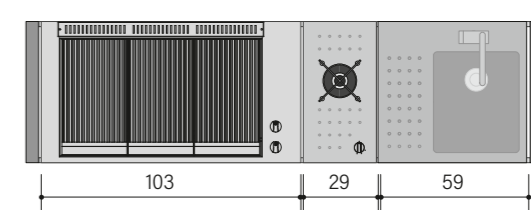
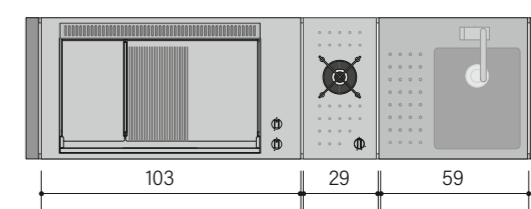
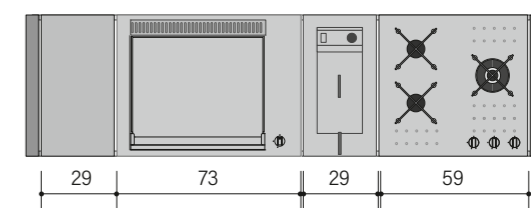
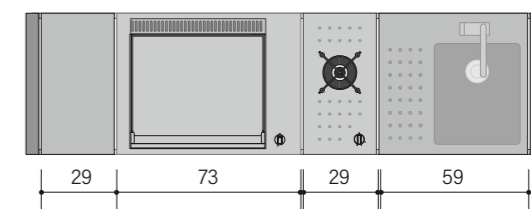

OASI 97 ICE

Outdoor Fridge

 L.97 x P.56 H.88 cm



1 97 ICE.2

2 97 ICE.3

Inox 304 - IPX4

Temperature 0°/10°C

N.3 piani estraibili

Vetro triplo strato (filtri UV)

EN_Stainless steel 304 - IPX4
 Temperature range 0°/10° C
 N.3 removable shelves
 3-coat insulating safety glass with UV filter
 DE_Edelstahl 304 - IPX 4
 Temperatur manuell einstellbar 0° / 10 °C
 3-lagiges Isolier-Sicherheitsglas mit UV-Filter
 FR_Acier inoxydable 304 - IPX4
 Plage de température 0°/ 10°
 3 étagères amovibles
 Verre de sécurité isolant à 3 couches avec filtre UV



Capacità 63 litri

(20 bottiglie)

EN_Storage volume 63 liter
 (20 bottles)
 DE_Lagervolumen 63 Liter
 (20 Flaschen)
 FR_Volume de stockage 63
 litres (20 bouteilles)



BUILT IN
IN.80 LR

CREDITS: CAPOCUOCO-ISRAELE

outdoor
BUILT-IN

OASI è una selezione di elementi singoli, tipici di una cucina, dalla cottura al lavello, utilizzabili per completare qualsiasi struttura venga progettata per la tua casa.

EN OASI is a selection of single elements, typical of a kitchen, from cooking to sink, which can be used to complete any structure designed for your home.

DE OASI besitzt viele einzelne Küchenelemente, von Kochplatte über die Spüle. Hiermit können Sie die für Ihr zuhause passende Struktur verwenden.

FR OASI est une composition d'éléments uniques, typiques d'une véritable cuisine, de la cuisson à l'évier, qui peuvent être utilisés pour compléter n'importe quelle structure conçue pour votre maison.

designer: PLA.NET Lab

Built.IN

/ Single elements



B.IN 80 LR
B.IN 80 L



B.IN 80 GRILL RR
B.IN 80 GRILL LR
B.IN 80 GRILL LL



B.IN 80 MIX LR
B.IN 80 MIX L

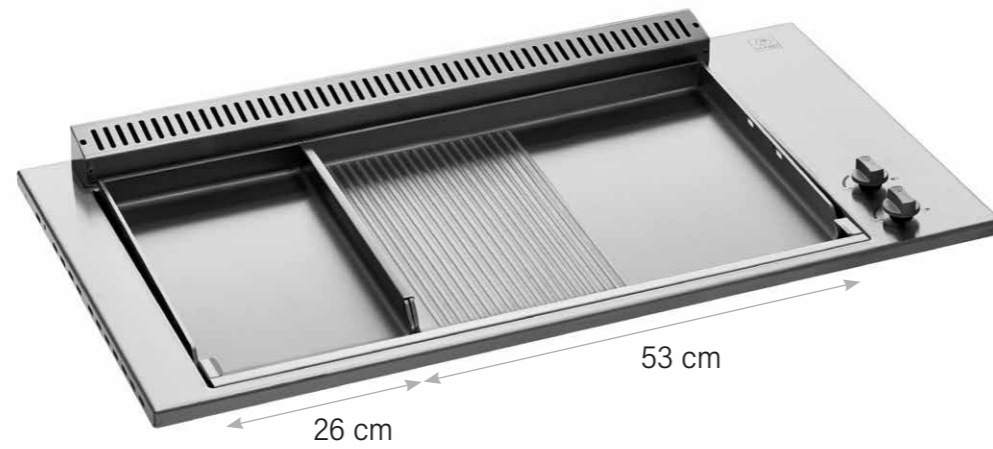

B.IN 55 LR
B.IN 55 L



B.IN 80 COMBI LR
B.IN 80 COMBI L



B.IN 55 COMBI LR
B.IN 55 COMBI L

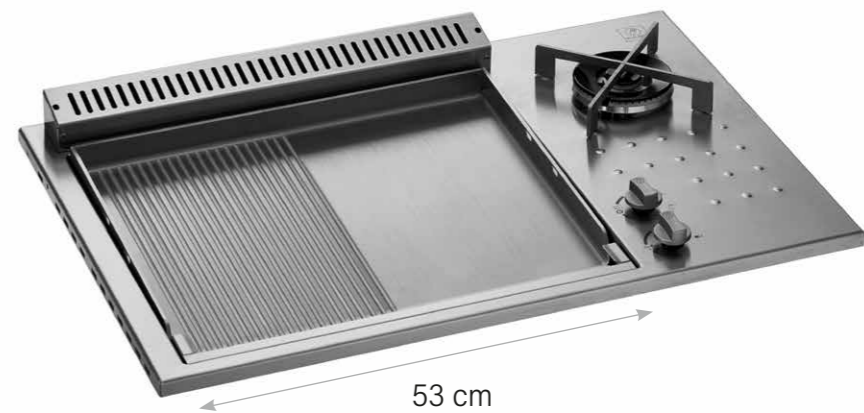

Gas collection



B.IN F3

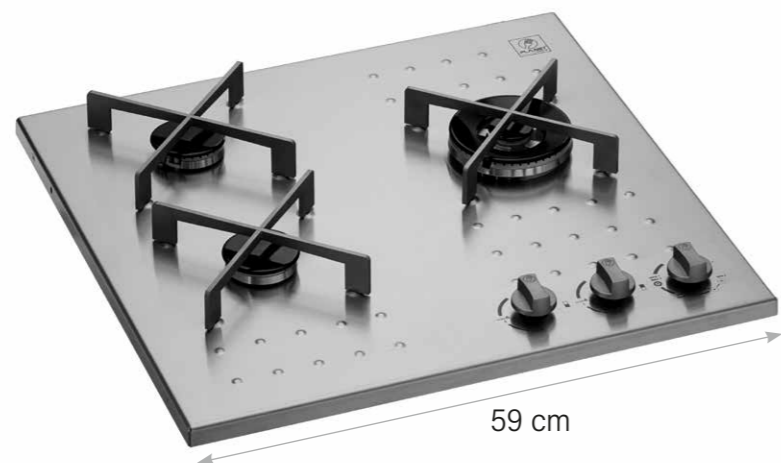

59 cm

B.IN LAV 4056



34 cm

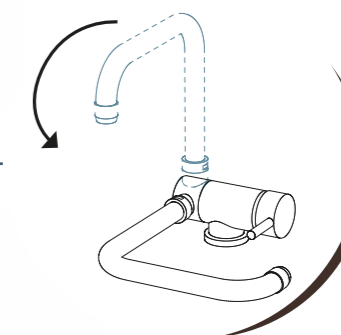

ART. SOTTO



B.IN F2

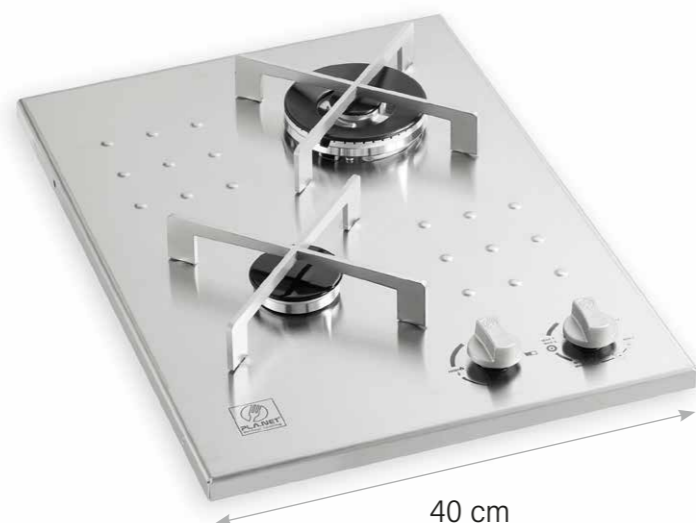

40 cm

B.IN LAV 5956



34 cm



B.IN F1

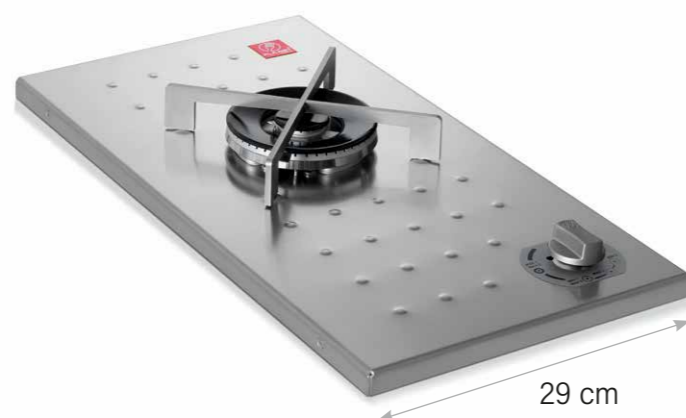

29 cm

TOP AISI 316 ACCESSORIO (non incluso)
ACCESSORY NOT INCLUDED



IN.COP 1150	80 COMBI
IN.COP 1030	80 - 80 MIX - 80 GRILL
IN.COP 850	55 COMBI - EL 60
IN.COP 730	55
IN.COP 590	F3 - LAV 5956
IN.COP 400	F2 - LAV 4056 - INDU
IN.COP 290	F1 - FR



B.IN INDU



B.IN EL60.L

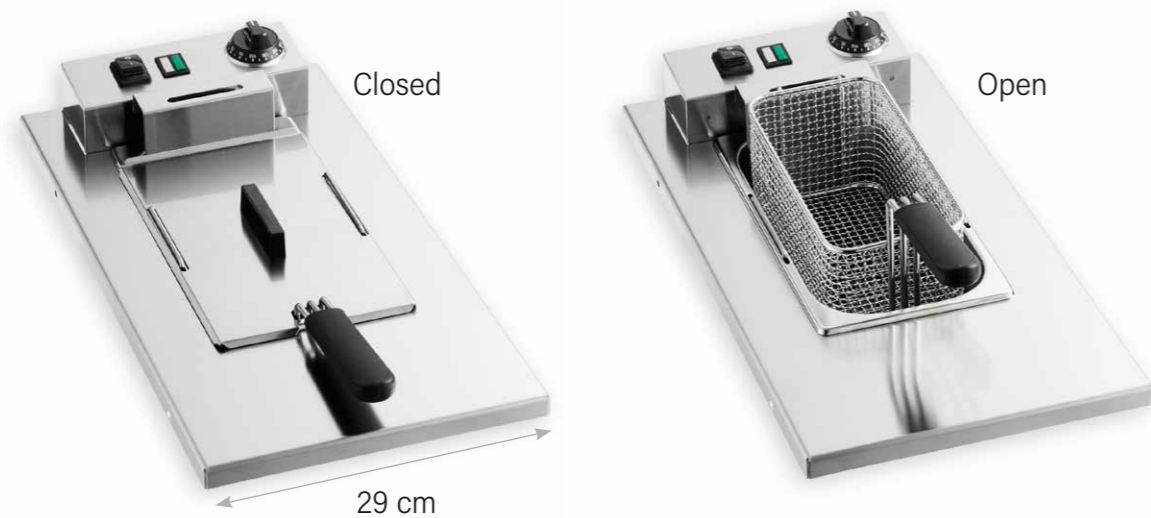

B.IN FR

Built.in / Top C5

Gas collection

IN. T1

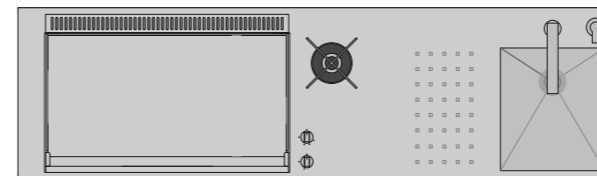

IN. T2

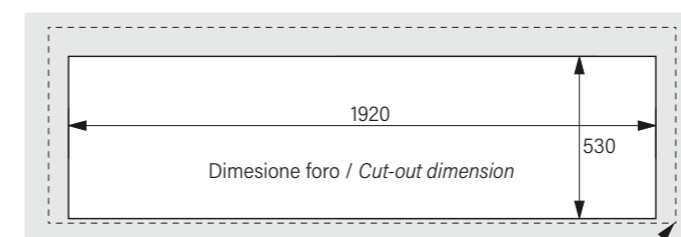
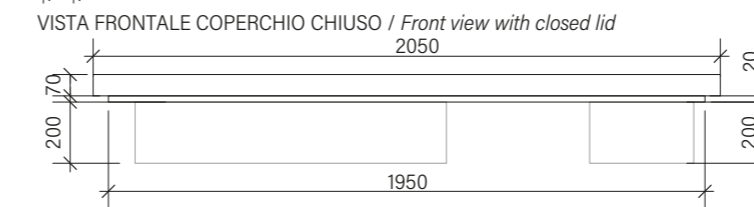
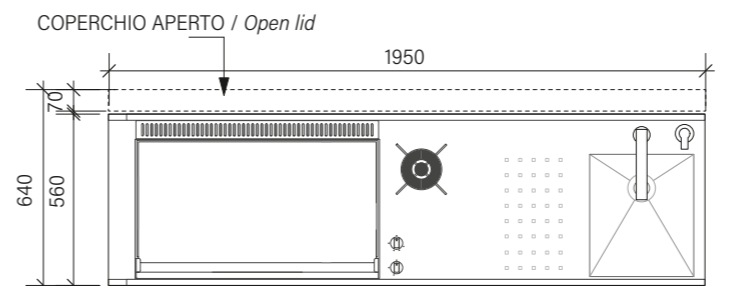
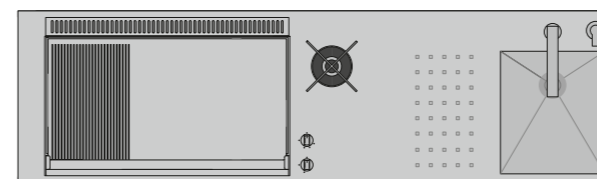

INGOMBRO PIANO COPERCHIO CHIUSO / Closed lid dimensions

Electric collection

IN. T7

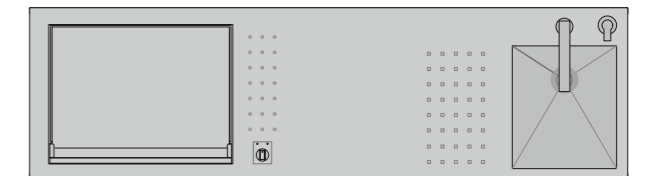

IN. T8

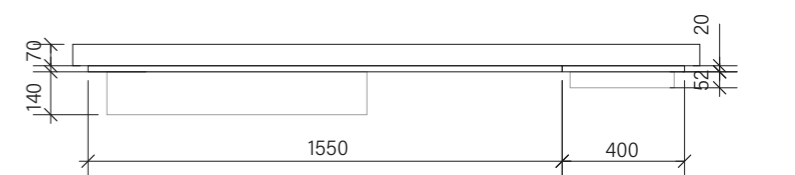
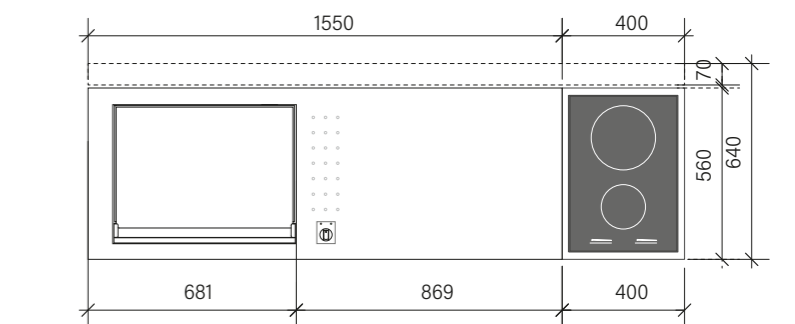
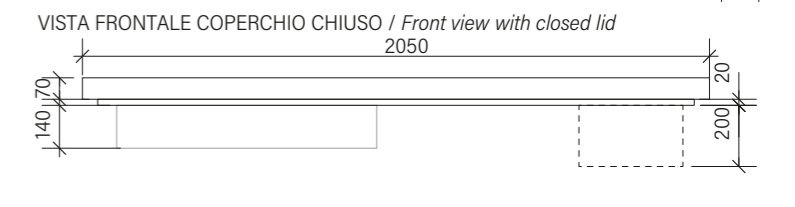
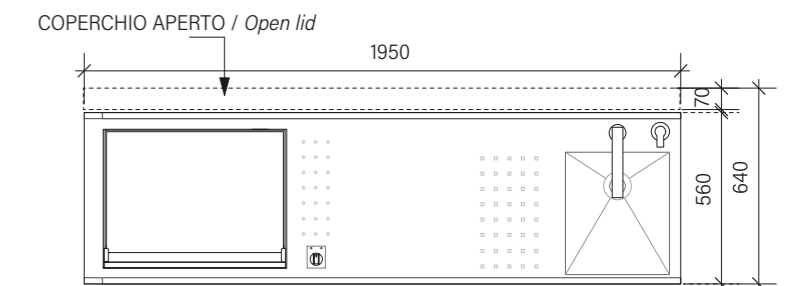
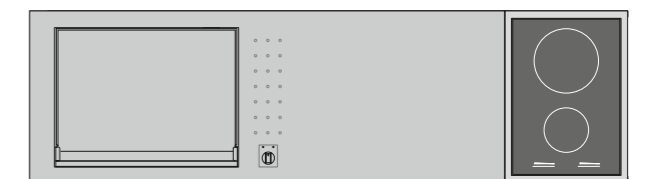

Installazione / installation

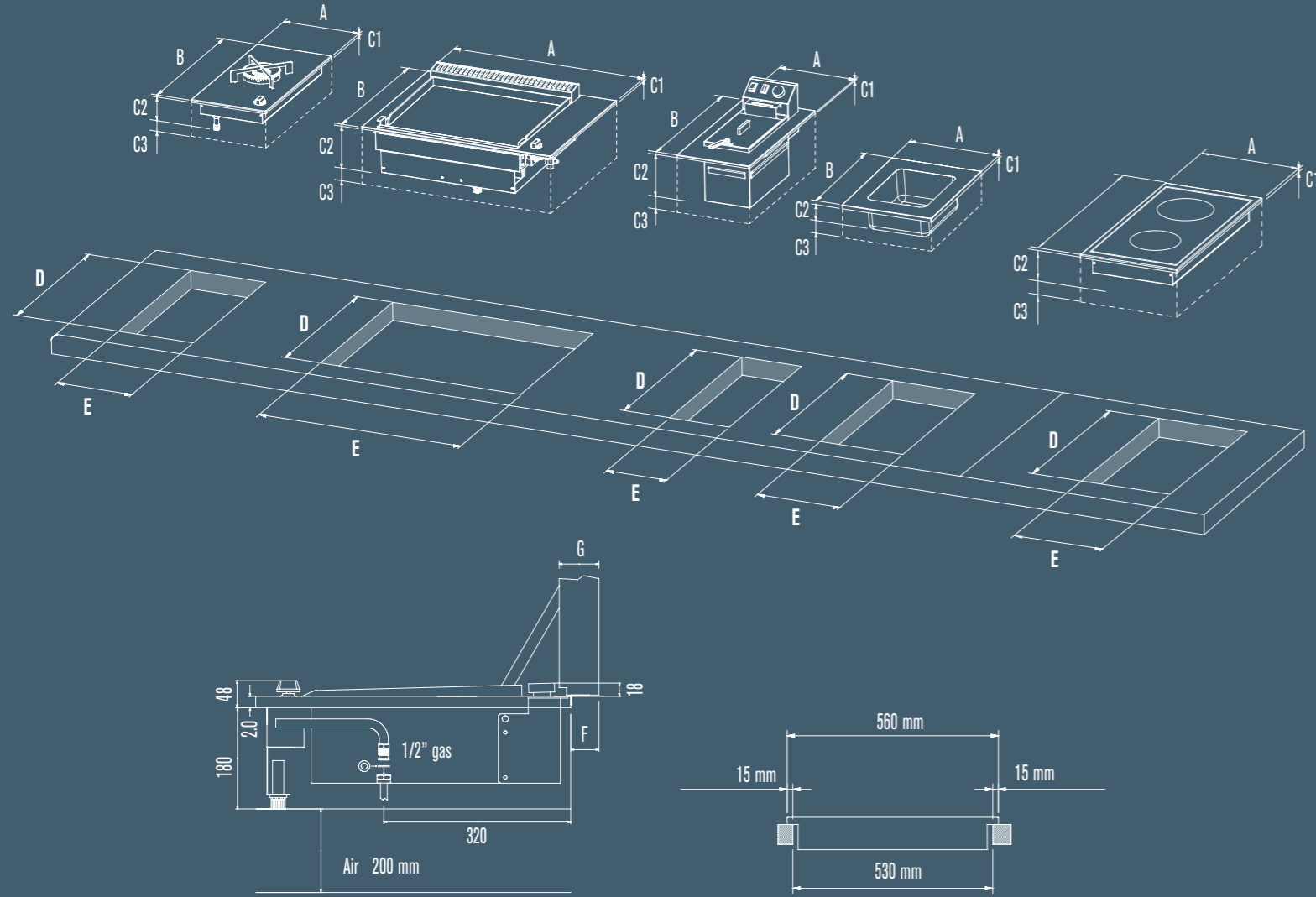

					S.S. / INOX		kW	V
IN.55 -55COMBI	GAS	AA 1,5V	PE0/I	P.G.S.	A 304L-316	6-8	-	-
IN.80-80MIX-80COMBI	GAS	AA 1,5V	PE0/I	P.G.S.	A 304L-316	10-12	-	-
IN.80 GRILL	GAS	AA 1,5V	PE0/I	P.G.S.	A 304L-316	10-12	-	-
IN.EL60	-	-	EL	IPX4	A 304L-316	8-10	2,4	230
IN.INDU	-	-	EL	IP22	A 304L-316	-	3,7	230

Dimensioni mm	A	B	C1	C2	C3	C2+C3	Foro installazione / Installation hole		F	G
							D	E		
IN.55	730	560	20	180	200	380	530	700	80	90
IN.80	1030	560	20	180	200	380	530	1000	80	90
IN.80 mix	1030	560	20	180	200	380	530	1000	80	90
IN.55 Combi	850	560	20	180	200	380	530	820	80	90
IN.80 Combi	1150	560	20	180	200	380	530	1120	80	90
IN.80 Grill	1030	560	20	180	200	380	530	1000	80	90
IN.F.1	290	560	20	90	150	240	530	260	80	90
IN.F.2	400	560	20	90	150	240	530	370	80	90
IN.F.3	590	560	20	90	150	240	530	560	80	90

Dimensioni mm	A	B	C1	C2	C3	C2+C3	Foro installazione / Installation hole		F	G
							D	E		
IN.EL60	850	560	20	140	150	290	530	820	80	90
IN.FR	290	560	20	190	50	240	530	260	80	90
IN.INDU	400	560	20	52	150	202	530	370	80	90

Dimensioni mm	A	B	C1	C2	C3	C2+C3	Foro installazione / Installation hole		F	G
							D	E		
IN.LAV5956	590	560	20	200	150	350	530	560	80	90
IN.LAV4056	400	560	20	200	150	350	530	370	80	90

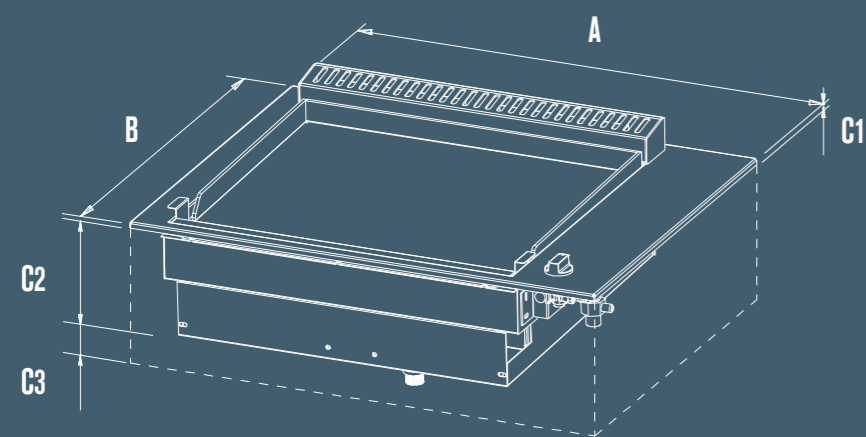
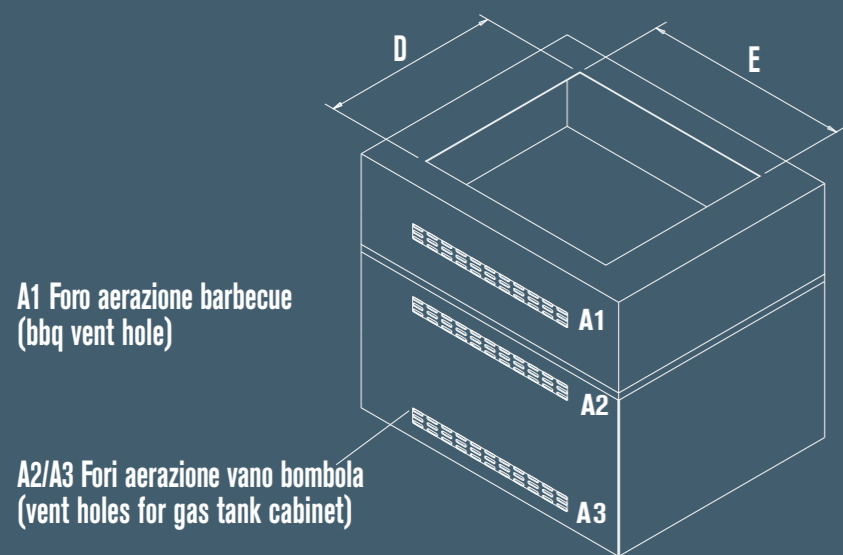

Dimensioni mm	Mod. IN.55	Mod. IN.80 IN.80mix
A	730	1030
B	560	560
C1	20	20
C2	180	180
C3	200	200
C2+C3	380	380
D	530	530
E	700	1000
A1	500 cm ²	750 cm ²
A2	200 cm ²	200 cm ²
A3	200 cm ²	200 cm ²

L'INSTALLAZIONE È MOLTO SEMPLICE. Basta predisporre un foro sul piano d'appoggio e inserirci il piano cottura, che potrà essere fissato al piano utilizzando le apposite staffe a "L" regolabili*, con perno filettato da avvitare al piano di appoggio. Collegare quindi l'entrata del gas alla bombola se predisposto per GPL (butano/propano) o alla rete se predisposto a metano. Attenzione: per il buon funzionamento dei prodotti (piastra di cottura), le manutenzioni e per la vostra sicurezza, è indispensabile seguire alcune avvertenze in merito a: materiali supporto, posizionamenti e distanze, aerazioni. Avvertenze disponibili su richiesta e presenti nel manuale istruzioni.

EN *It's very simple. It's enough to set a hole on the support board and insert the hob which can be fixed by means of designated L-shaped adjustable brackets*, with a threaded pin to be screwed to the supporting top. Connect the inlet of gas to the bottle if set for LPG (butane-propane) or to the main supply if set for methane. Attention: for the correct operation (of the cook top), for the maintenance and for your safety, it is necessary to follow a few warnings/rules concerning: support materials, placement and distances, ventilation. Warnings available on request and specified in the instruction manual.*

DE *Sehr einfach. Sie müssen nur eine Öffnung auf der Auflagefläche ausschneiden und die Grillplatte einlassen; diese kann mit Hilfe der entsprechend einstellbaren "L"-förmigen Bügel an der Platte befestigt und mit dem Gewindestift an die Auflagefläche* angeschraubt werden. Anschließend müssen Sie den Gaseingang an die Gasflasche (bei Flüssiggas Butan/Propan) bzw. an die Erdgasleitung anschließen. Achtung für eine einwandfreie Funktion der Produkte (insbesondere die Grillplatte), eine leichte Wartung und zu Ihrer Sicherheit müssen Sie die Hinweise zu Stützmaterialien, Positionierungen und Entfernungen sowie zur Lüftung beachten. Die Hinweise werden auf Anfrage mitgeteilt und sind auch in der Bedienungsanleitung aufgeführt.*

FR *Extrêmement simple. Il suffit de réaliser une découpe sur le plan de travail et d'insérer le plan de cuisson, qui pourra être vissé dessus avec l'étrier réglable en L à tige fileté*. Puis raccorder l'entrée du gaz à la bouteille pour le GPL (butane/propane) ou à votre installation au gaz de ville (méthane) selon votre souhait. Attention: pour le correct fonctionnement des produits (en particulier plan de cuisson), la maintenance et pour votre sécurité, il faut suivre quelques précautions concernant: matériel support, placement et distances, aération. Précautions disponibles sur requête et notées dans le manuel d'instructions.*

* Su richiesta /
On request

Portfolio

/ Client Projects



private house FRANCE



private house GREECE

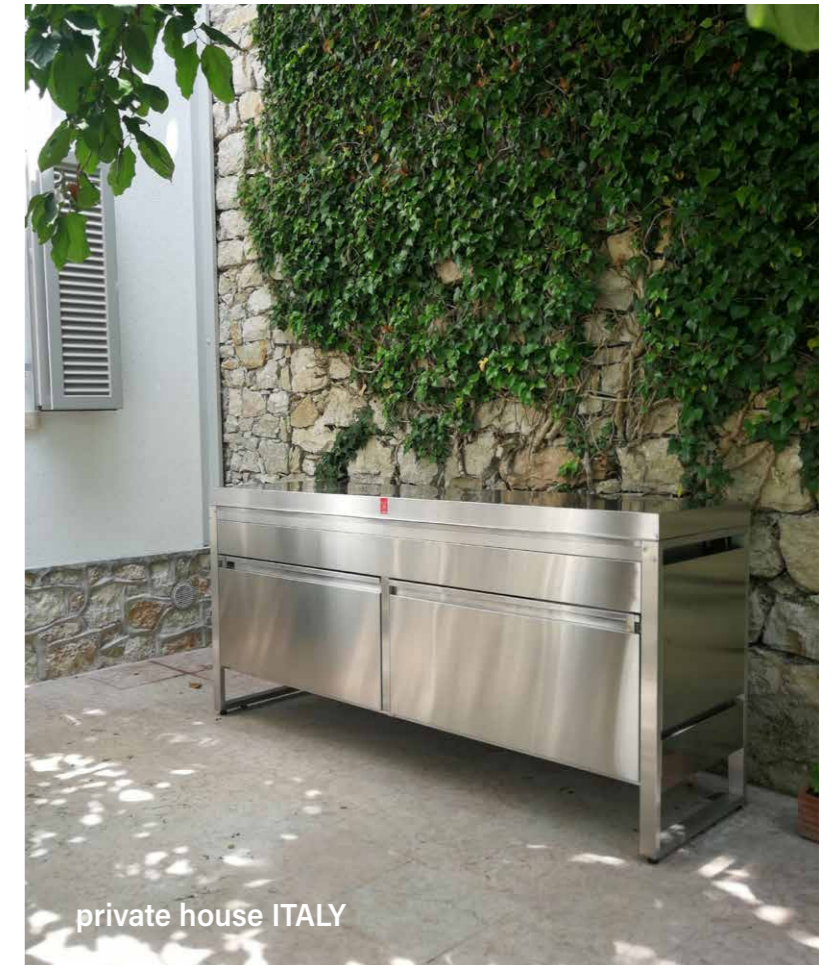

private house ITALY



private house SPAIN



private house GREAT BRITAIN



private house ISRAEL

Portfolio

/ Client Projects



private house ITALY



private house MILAN

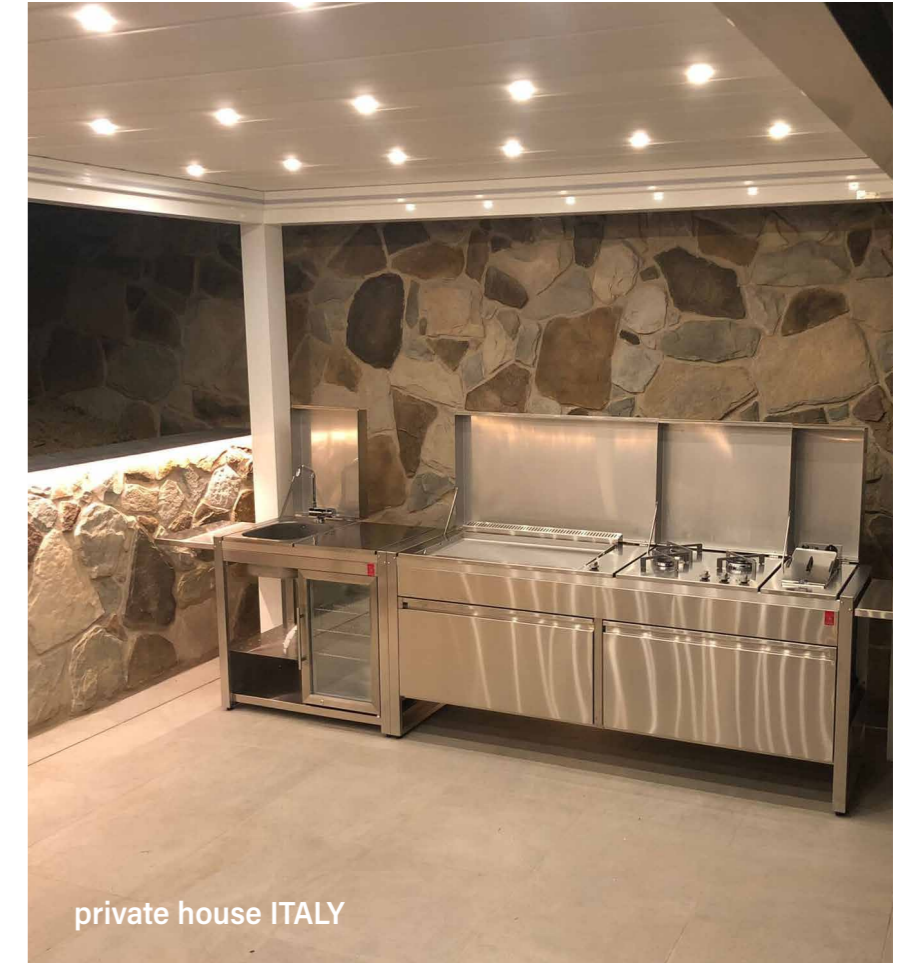

private house ITALY

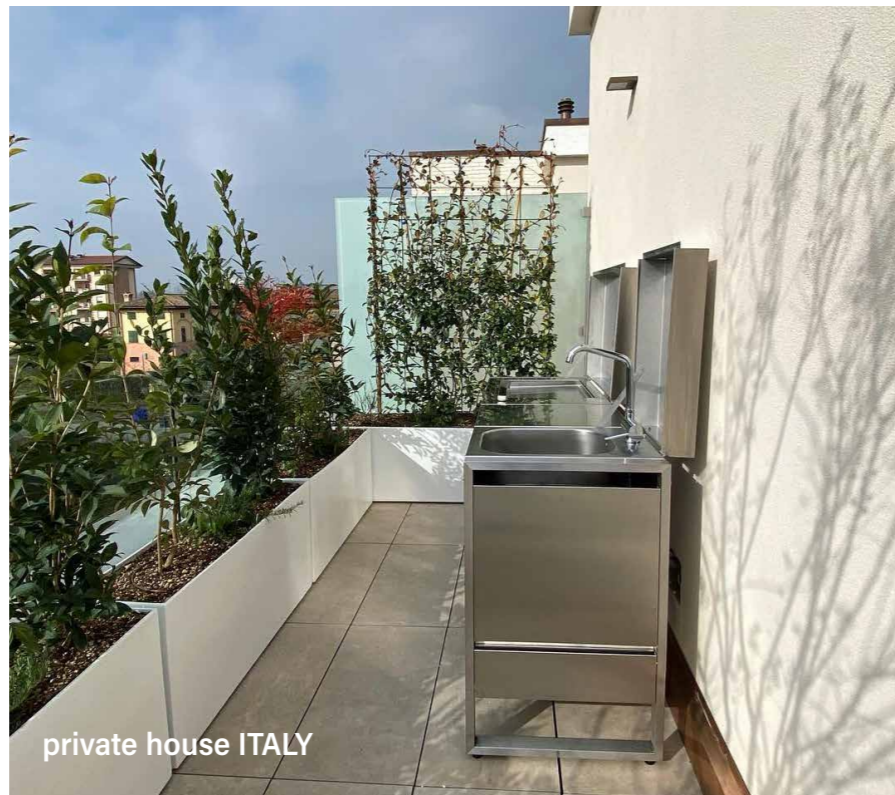

private house ITALY



private house ISRAEL

▪ **Accessori**
Accessories

Art. IN.COP
Built-IN collection



▪ **COPERCHIO TOP** / Top lids

Art. COVER
97-142-183-205



▪ **TELO OASI** / Cover OASI



▪ **BARRA LED** / Led bar

Art. KIT 4WD



▪ **RUOTE CON FRENO** / Wheels with brake

Art. BOWL



▪ **COPERCHIO COTTURA** / Cooking Lid

Art. KIT.4.ACC
Art. A.PAL
Art. A.PIN
Art. A.COL
Art. A.FOR



▪ **SET ATTREZZI COTTURA**
/ Cooking tools



▪ **RASCHIETTO** / Scraper
In **GRILL 80** incluso / included



▪ **CONTENITORE** / Case

▪ **Accessori Pulizia**
Cleaning accessories

Art. CLEAN.INOX500
(n.6 pezzi)



Art. CONF.RALL
Art. CONF.LL



Art. C.P.MAXI



Art. CLEAN.PLANET500
(n.6 pezzi)



Art. CONF.PABR



Art. C.P.EASY



Acciaio INOX (AISI - Stainless Steel)

Diverse le tipologie in commercio, sotto la denominazione di acciaio AISI (American Iron and Steel Institute). E una lega caratterizzata dall'alta resistenza all'ossidazione e corrosione grazie alla presenza di Cromo e Nichel in varie percentuali. Molti i campi di impiego e le sigle (leghe) che li identificano (settore: alimentare, casalingo, arredamento, navale e costruzioni). / STAINLESS STEEL (AISI) AISI (American Iron and Steel Institute) characterizes different type of SS all over marketplace, this particular kind of alloy is marked by high resistance to oxidation and corrosion, thanks to chromium and nickel's settlement in various propotion. This type of Stainless Steel (used for example for food, home, furnishing, shipbuilding and buildings) has different field application and it is identified by different acronyms.

PLA.NET utilizza da sempre tre tipologie di acciaio INOX:

INOX A.430: buona resistenza all'ossidazione e massima conducibilità del calore. Il più utilizzato nel settore alimentare e casalingo.

INOX A.304L: (18/10) ottima resistenza all'ossidazione e ottima conducibilità del calore. Il materiale principe nel settore della ristorazione professionale.

INOX A.316: massima resistenza all'ossidazione e buona conducibilità del calore. Indicato anche come marino, per il suo impiego nel settore navale e chimico.

Manutenzione acciaio INOX:

I prodotti PLA.NET possono essere lasciati all'aperto. È necessaria tuttavia qualche precauzione per un buon mantenimento del prodotto dato che anche l'acciaio inox, come tutti i materiali, ha bisogno di cura e manutenzione, che varia in base alle sue caratteristiche (tipologie acciaio) e all'ambiente in cui si trova, più o meno aggredibile dalle condizioni ambientali e atmosferiche. La sua bellezza e durata dipende solo da questo. Per maggiori informazioni: vedi il sito PLA.NET alla voce istruzioni.

PLA.NET has always used 3 types of Stainless Steel:

A.430: good oxidation resistance and maximum heat conductivity. The most used Stainless Steel in food and home industry.

A.304L: (18/10) excellent oxidation resistance and excellent heat conductivity. The main material in the professional cooking sector.

A.316: maximum oxidation resistance and good heat conductivity. Named also as "marine steel", about its use in the naval and chemical industries.

Stainless steel maintenance

Our products can be left outdoors. However, some precautions are necessary for a good maintenance of the product. Stainless Steel, like every material, needs care and maintenance, different for the type of material and environment in which it's located (more or less vulnerable to environmental and atmospheric conditions). Beauty and durability of every material depends only on this. For more information: see the PLA.NET website under instructions.



Produzione e qualità italiana dal 1988: valore al processo industriale e alla cura artigianale. / Manufacturing and Italian quality since 1988: added value to the industrial process and artisan craftsmanship.



Società fondata nel 1988 da operatori esperti nella lavorazione dell'acciaio inox nel settore della ristorazione professionale. Situata nel nord-est d'Italia, nel distretto di Conegliano (Treviso), specializzato nella produzione di elettrodomestici e impianti per la ristorazione professionale. Si sviluppa in due unità produttive per 5.000mq coperti. Da questo know how, nel 2005 nasce il progetto a marchio PLA.NET, che propone la cottura su piastra acciaio inox, all'esterno, destinata alla famiglia, quale evoluzione del sistema tradizionale barbecue. Una sintesi delle esperienze internazionali di cottura su piastra. / *The company was founded in 1988 by experts in stainless steel processing in the professional catering sector. It is located in the north-east of Italy, in the district of Conegliano (Treviso) and is specialized in the production of home appliances and systems for professional catering. It is made up of two production units covering 5,000 sq m. As a result of this know-how, the PLA.NET brand project was launched in 2005; a brand that offers stainless steel plate cookers, external use, for the family, as an evolution of the traditional barbecue system. A combination of international cooking experiences on a single hot plate.*



UNIT 1 Dedicata alla lavorazione di laminati piani come acciaio, acciaio inox, bimetallo (acciaio+acciaio inox) trimetallo (inox+alluminio+inox), con spessori da 5 a 40mm. Ciclo lavorazione completo: taglio, fresatura, tornitura, satinatura, lucidatura, saldatura robotizzata, pallinatura, pulitura. Realizzazione di piani cottura destinati al settore della ristorazione e cottura domestica. Per un totale di 2400 mq. / *Area dedicated to processing flat laminates such as steel, stainless steel, bimetal (steel + stainless steel) tri-metal (stainless + aluminium + stainless steel), with thickness ranging from 5 to 40 mm. Complete processing cycle: cutting, milling, turning, satin finishing, polishing, robotic welding, shot blasting, cleaning. We manufacture hobs for the catering and domestic cooking sector. For a total of 2,400 sq m.*

UNIT 2 Dedicata alla lavorazione dell'acciaio inox con spessori da 0,8 a 3mm. Ciclo lavorazione completo: taglio, punzonatura, piegatura, satinatura, saldatura robot, pallinatura, pulitura, assemblaggio. Si realizzano componenti in acciaio inox per il settore della ristorazione professionale che per la cottura domestica come: fry top, teppanyaki, piastre di cottura per barbecue, carrelli, tavoli. Superficie occupata 2.600 mq / *Area dedicated to processing stainless steel with thicknesses ranging from 0.8 to 3 mm. Complete processing cycle: cutting, punching, bending, satin finishing, robot welding, shot blasting, cleaning, and assembly. We manufacture stainless steel components, for both the professional catering sector and the domestic cooking sector, such as: fry tops, teppanyaki, cooking plates for barbecues, trolleys, tables. Area occupied - 2.600 sq m*

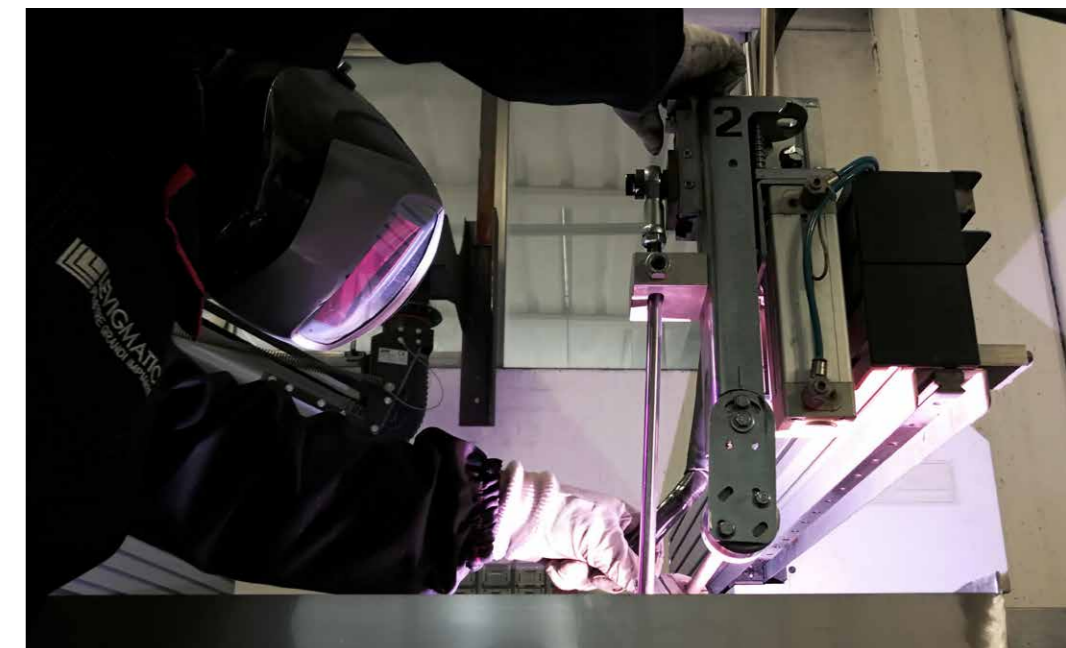

Levigmatic:

5 continents
24 countries

EUROPA

Austria
Belgio
Croazia
Finlandia
Francia
Germania
Gran Bretagna
Grecia
Italia
Olanda
Polonia
Portogallo
Rep. Ceca
Slovenia
Spagna
Svizzera

AFRICA

Algeria

AMERICA

Brasile
Canada

ASIA

Indonesia
Israele
Giordania

OCEANIA

Australia
Nuova Zelanda



PLA.NET®

è un brand:

levigmatic
catering equipment

Production unit 1
LEVIGMATIC Professional Cooking

Via dell'Industria, 71
31020 San Vendemiano (TV)
Tel: +39 0438 778161
Fax: +39 0438 778385
www.levigmatic.it

Production unit 2
PLA.NET Outdoor Cooking

Via dell'Industria, 39
31020 San Vendemiano (TV)
Tel: +39 0438 470552
Fax: +39 0438 478705
info@planetbarbecue.it
www.planetbarbecue.it

CREDITS:

Art direction Pla.net: Arch. Marco De Luca
Graphic Design: Mirco Luzzi
Photo: Studio Rocci

Thanks to:

Fabrizio Nonis BEKÉR - On Tour
Berto's S.p.a. (foto)

Levigmatic Srl si riserva di apportare ai propri prodotti qualsiasi modifica ritenuta utile al miglioramento qualitativo degli stessi, sia dimensionale che strutturale. Foto, disegni e testi non hanno carattere contrattuale. / Levigmatic Srl reserves the right to make any modifications to its products that it feels may improve their appearance or quality, either dimensional or structural. Photos, drawings and texts are not contractually binding.

Tutti I diritti riservati. E' vietata la riproduzione anche parziale delle immagini e testi. / All rights reserved. The reproduction of image, drawings and texts, even if partial, is forbidden.

L'azienda è da sempre impegnata al rispetto delle normative e certificazioni vigenti, all'utilizzo di materiali certificati idonei al contatto dei cibi (MOCA) per garantire la migliore qualità dei propri prodotti e al loro utilizzo per la cottura degli alimenti in sicurezza.

The company has always been engaged to compliance with current regulations and certifications, the use of certified materials suitable for contact with foods (MOCA) to ensure the best quality of its products and their use for cooking food safely.

Certificazioni / Certifications

CE:

GAR 2016/426 EU

EN 30-1-1

EN 30-2-1

En 498

c UL us:

ANSI Z21.58b-2012/CSA 1.6-2015

Enti / Certification Authorities

IMQ SpA

UL LLC

PLA.NET Outdoor Cooking

Via dell'Industria, 39
31020 San Vendemiano (TV)
Tel: +39 0438 470552
Fax: +39 0438 478705

info@planetbarbecue.it
www.planetbarbecue.it



products strictly made in Italy